



STY34NB50F

N - CHANNEL 500V - 0.11Ω - 34 A - Max247 PowerMESH™ MOSFET

TYPE	V _{DSS}	R _{DS(on)}	I _D
STY34NB50F	500 V	< 0.14 Ω	34 A

- TYPICAL R_{DS(on)} = 0.11 Ω
- EXTREMELY HIGH dv/dt CAPABILITY
- ± 30V GATE TO SOURCE VOLTAGE RATING
- 100% AVALANCHE TESTED
- LOW INTRINSIC CAPACITANCE
- GATE CHARGE MINIMIZED
- REDUCED VOLTAGE SPREAD

DESCRIPTION

Using the latest high voltage MESH OVERLAY™ process, STMicroelectronics has designed an advanced family of power MOSFETs with outstanding performances. The new patent pending strip layout coupled with the Company's proprietary edge termination structure, gives the lowest R_{DS(on)} per area, exceptional avalanche and dv/dt capabilities and unrivalled gate charge and switching characteristics.

APPLICATIONS

- HIGH CURRENT, HIGH SPEED SWITCHING
- SWITCH MODE POWER SUPPLY (SMPS)
- DC-AC CONVERTER FOR WELDING EQUIPMENT AND UNINTERRUPTABLE POWER SUPPLY AND MOTOR DRIVE

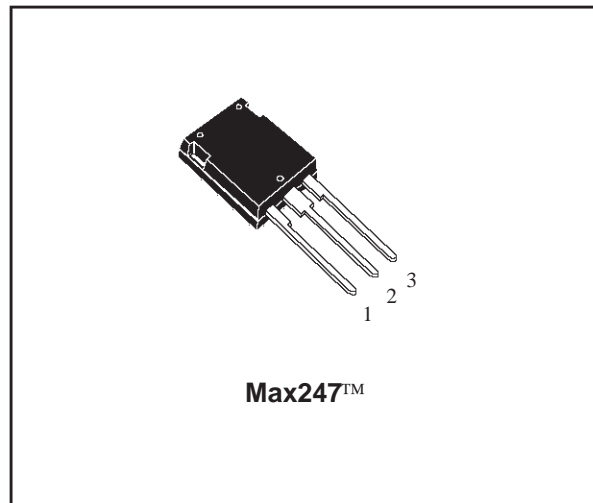

INTERNAL SCHEMATIC DIAGRAM

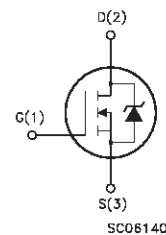

ABSOLUTE MAXIMUM RATINGS

Symbol	Parameter	Value	Unit
V _{DS}	Drain-source Voltage (V _{GS} = 0)	500	V
V _{DGR}	Drain- gate Voltage (R _{GS} = 20 kΩ)	500	V
V _{GS}	Gate-source Voltage	± 30	V
I _D	Drain Current (continuous) at T _c = 25 °C	34	A
I _D	Drain Current (continuous) at T _c = 100 °C	21.4	A
I _{DM} (•)	Drain Current (pulsed)	136	A
P _{tot}	Total Dissipation at T _c = 25 °C	450	W
	Derating Factor	3.61	W/°C
dv/dt(1)	Peak Diode Recovery voltage slope	4.5	V/ns
T _{stg}	Storage Temperature	-65 to 150	°C
T _j	Max. Operating Junction Temperature	150	°C

(•) Pulse width limited by safe operating area

(1) I_{SD} ≤ 34 A, di/dt ≤ 200 A/μs, V_{DD} ≤ V_{(BR)DSS}, T_j ≤ T_{JMAX}

STY34NB50F

THERMAL DATA

$R_{thj-case}$	Thermal Resistance Junction-case	Max	0.277	$^{\circ}C/W$
$R_{thj-amb}$	Thermal Resistance Junction-ambient	Max	30	$^{\circ}C/W$
$R_{thc-sink}$	Thermal Resistance Case-sink	Typ	0.1	$^{\circ}C/W$
T_I	Maximum Lead Temperature For Soldering Purpose		300	$^{\circ}C$

AVALANCHE CHARACTERISTICS

Symbol	Parameter	Max Value	Unit
I_{AR}	Avalanche Current, Repetitive or Not-Repetitive (pulse width limited by T_j max)	34	A
E_{AS}	Single Pulse Avalanche Energy (starting $T_j = 25^{\circ}C$, $I_D = I_{AR}$, $V_{DD} = 50 V$)	1000	mJ

ELECTRICAL CHARACTERISTICS ($T_{case} = 25^{\circ}C$ unless otherwise specified)

OFF

Symbol	Parameter	Test Conditions	Min.	Typ.	Max.	Unit
$V_{(BR)DSS}$	Drain-source Breakdown Voltage	$I_D = 250 \mu A$ $V_{GS} = 0$	500			V
I_{DSS}	Zero Gate Voltage Drain Current ($V_{GS} = 0$)	$V_{DS} = \text{Max Rating}$ $V_{DS} = \text{Max Rating}$ $T_c = 125^{\circ}C$			10 100	μA μA
I_{GSS}	Gate-body Leakage Current ($V_{DS} = 0$)	$V_{GS} = \pm 30 V$			± 100	nA

ON (*)

Symbol	Parameter	Test Conditions	Min.	Typ.	Max.	Unit
$V_{GS(th)}$	Gate Threshold Voltage	$V_{DS} = V_{GS}$ $I_D = 250 \mu A$	3	4	5	V
$R_{DS(on)}$	Static Drain-source On Resistance	$V_{GS} = 10 V$ $I_D = 17 A$		0.11	0.14	Ω
$I_{D(on)}$	On State Drain Current	$V_{DS} > I_{D(on)} \times R_{DS(on)max}$ $V_{GS} = 10 V$	34			A

DYNAMIC

Symbol	Parameter	Test Conditions	Min.	Typ.	Max.	Unit
g_{fs} (*)	Forward Transconductance	$V_{DS} > I_{D(on)} \times R_{DS(on)max}$ $I_D = 17 A$		27		S
C_{iss}	Input Capacitance	$V_{DS} = 25 V$ $f = 1 MHz$ $V_{GS} = 0$		5.9		nF
C_{oss}	Output Capacitance			880		pF
C_{rss}	Reverse Transfer Capacitance			80		pF

ELECTRICAL CHARACTERISTICS (continued)

SWITCHING ON

Symbol	Parameter	Test Conditions	Min.	Typ.	Max.	Unit
$t_{d(on)}$	Turn-on Time	$V_{DD} = 250\text{ V}$ $I_D = 17\text{ A}$		45		ns
t_r	Rise Time	$R_G = 4.7\ \Omega$ $V_{GS} = 15\text{ V}$ (see test circuit, figure 3)		35		ns
Q_g	Total Gate Charge	$V_{DD} = 400\text{ V}$ $I_D = 34\text{ A}$ $V_{GS} = 10\text{ V}$		140	196	nC
Q_{gs}	Gate-Source Charge			38		nC
Q_{gd}	Gate-Drain Charge			61		nC

SWITCHING OFF

Symbol	Parameter	Test Conditions	Min.	Typ.	Max.	Unit
$t_{r(Voff)}$	Off-voltage Rise Time	$V_{DD} = 400\text{ V}$ $I_D = 17\text{ A}$		28		ns
t_f	Fall Time	$R_G = 4.7\ \Omega$ $V_{GS} = 15\text{ V}$		30		ns
t_c	Cross-over Time	(see test circuit, figure 5)		60		ns

SOURCE DRAIN DIODE

Symbol	Parameter	Test Conditions	Min.	Typ.	Max.	Unit
I_{SD}	Source-drain Current				34	A
$I_{SDM}(\bullet)$	Source-drain Current (pulsed)				136	A
$V_{SD}(\ast)$	Forward On Voltage	$I_{SD} = 34\text{ A}$ $V_{GS} = 0$			1.6	V
t_{rr}	Reverse Recovery Time	$I_{SD} = 34\text{ A}$ $di/dt = 100\text{ A}/\mu\text{s}$ $V_{DD} = 100\text{ V}$ $T_j = 150\text{ }^\circ\text{C}$ (see test circuit, figure 5)		715		ns
Q_{rr}	Reverse Recovery Charge			11.8		μC
I_{RRM}	Reverse Recovery Current			33		A

(*) Pulsed: Pulse duration = 300 μs , duty cycle 1.5 %

(•) Pulse width limited by safe operating area

Safe Operating Area

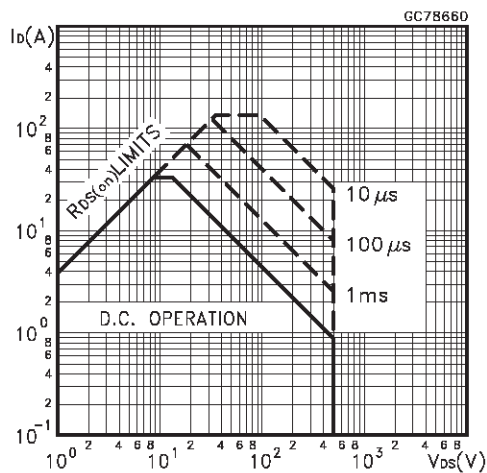

Thermal Impedance

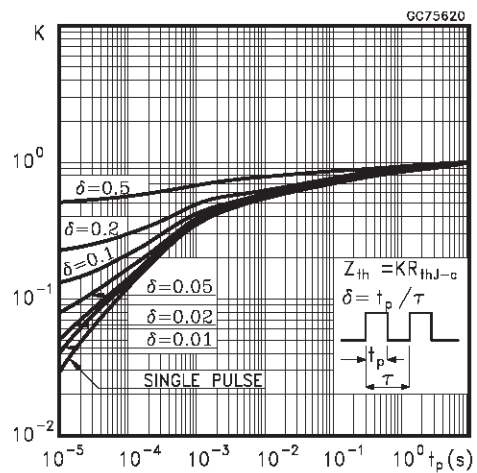

Output Characteristics

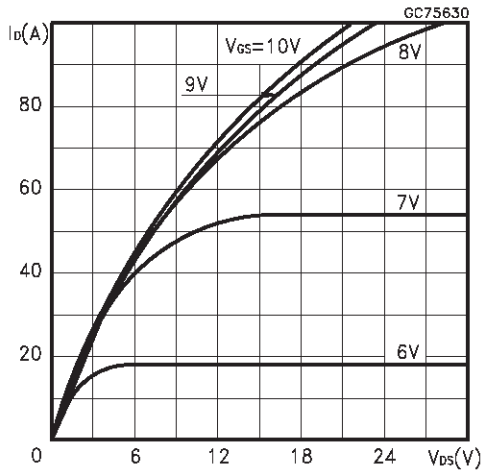

Transfer Characteristics

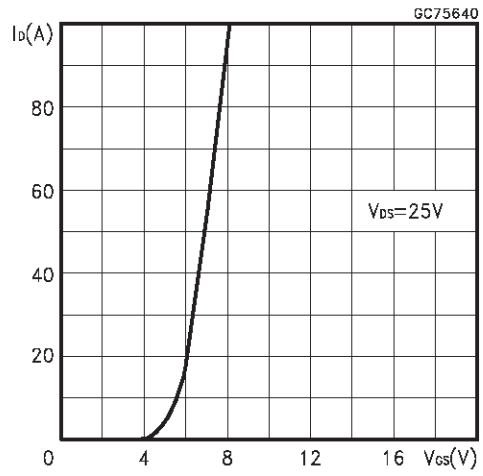

Transconductance

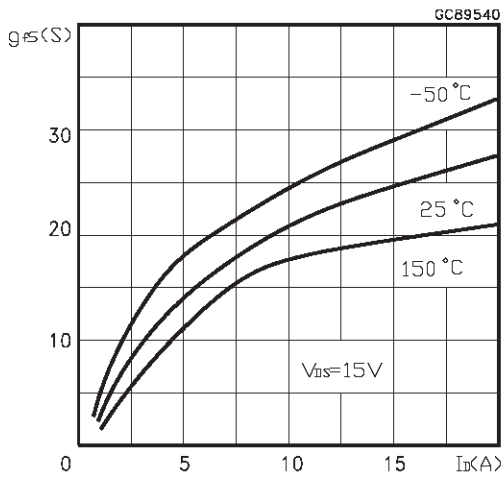

Static Drain-source On Resistance

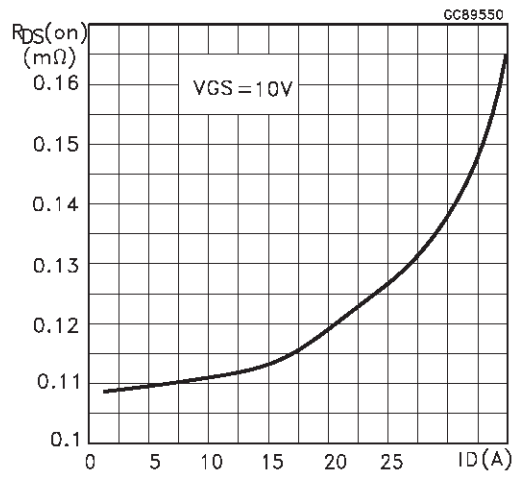

Gate Charge vs Gate-source Voltage

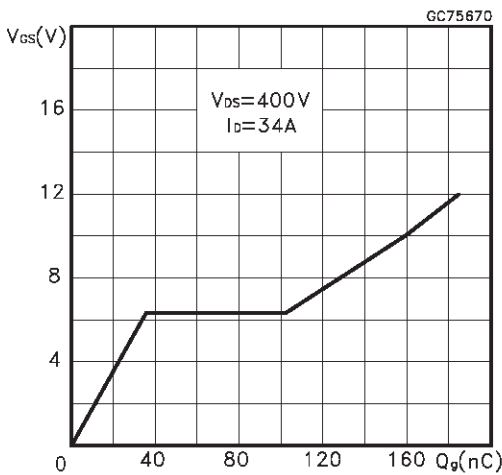

Capacitance Variations

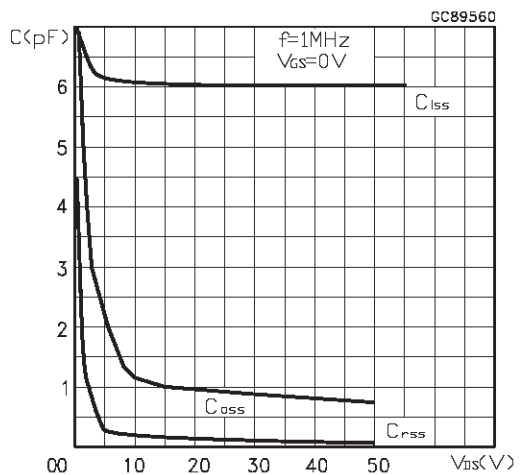

Normalized Gate Threshold Voltage vs Temperature

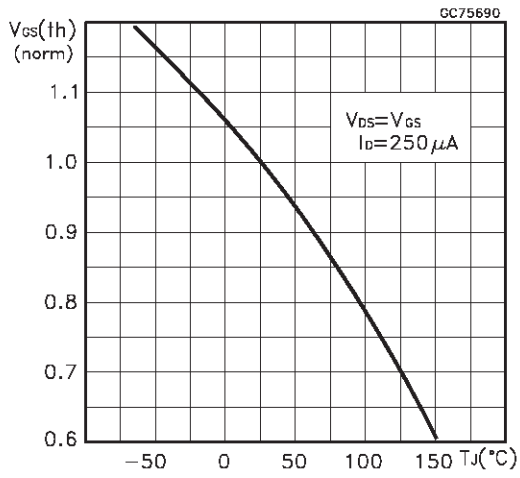

Normalized On Resistance vs Temperature

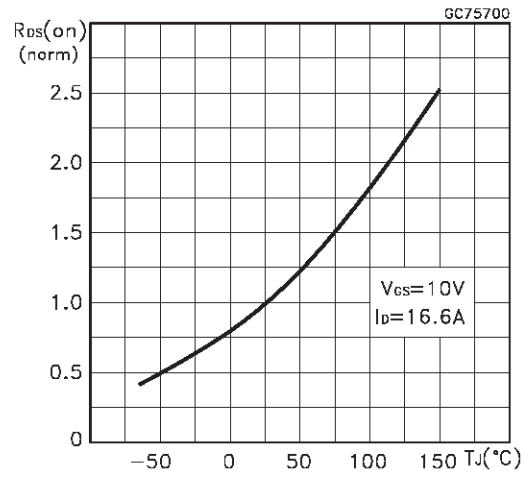

Source-drain Diode Forward Characteristics

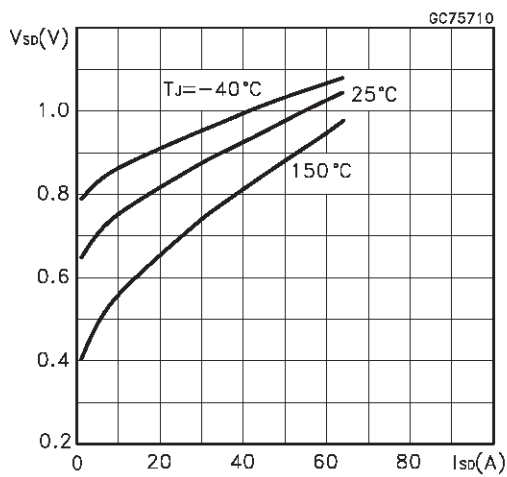

Fig. 1: Unclamped Inductive Load Test Circuit



Fig. 2: Unclamped Inductive Waveform



Fig. 3: Switching Times Test Circuits For Resistive Load



Fig. 4: Gate Charge test Circuit

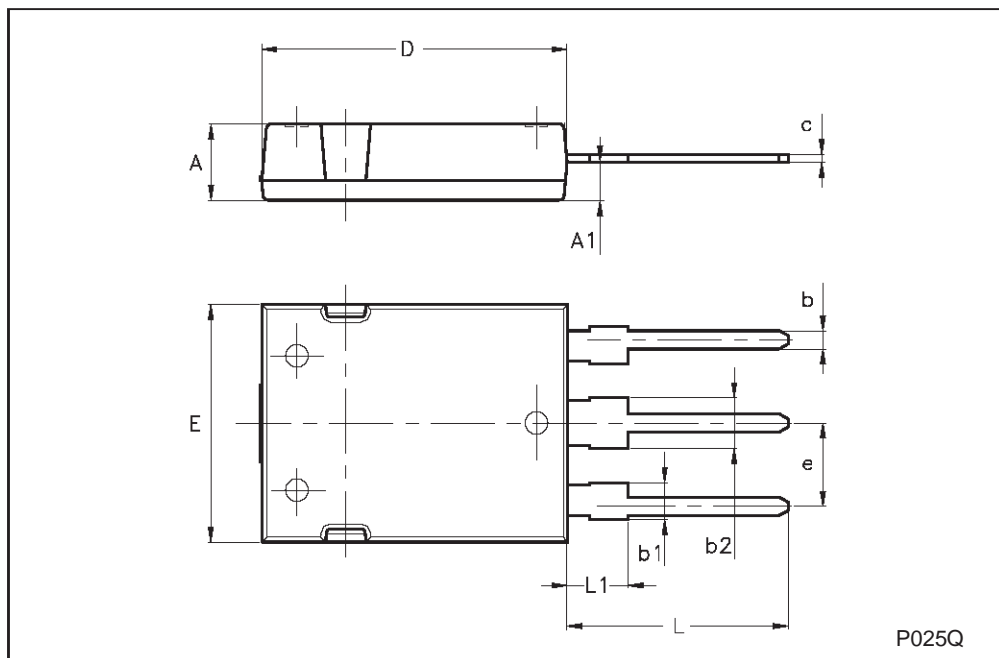

Fig. 5: Test Circuit For Inductive Load Switching And Diode Recovery Times



Max247 MECHANICAL DATA

DIM.	mm			inch		
	MIN.	TYP.	MAX.	MIN.	TYP.	MAX.
A	4.70		5.30			
A1	2.20		2.60			
b	1.00		1.40			
b1	2.00		2.40			
b2	3.00		3.40			
c	0.40		0.80			
D	19.70		20.30			
e	5.35		5.55			
E	15.30		15.90			
L	14.20		15.20			
L1	3.70		4.30			



Information furnished is believed to be accurate and reliable. However, STMicroelectronics assumes no responsibility for the consequences of use of such information nor for any infringement of patents or other rights of third parties which may result from its use. No license is granted by implication or otherwise under any patent or patent rights of STMicroelectronics. Specification mentioned in this publication are subject to change without notice. This publication supersedes and replaces all information previously supplied. STMicroelectronics products are not authorized for use as critical components in life support devices or systems without express written approval of STMicroelectronics.

The ST logo is a trademark of STMicroelectronics

© 1999 STMicroelectronics – Printed in Italy – All Rights Reserved
STMicroelectronics GROUP OF COMPANIES

Australia - Brazil - China - Finland - France - Germany - Hong Kong - India - Italy - Japan - Malaysia - Malta - Morocco -
Singapore - Spain - Sweden - Switzerland - United Kingdom - U.S.A.